

Montageanleitung

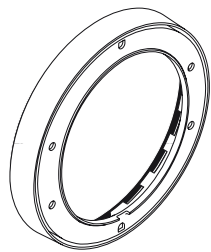

13596XXX

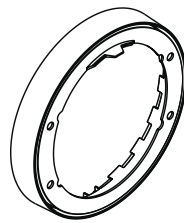

13597XXX

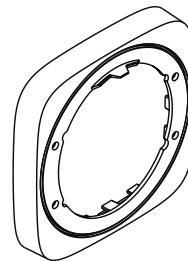

15597000

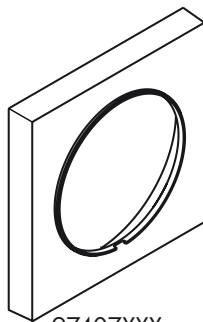

97407XXX

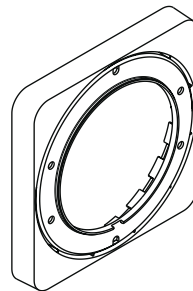

98860000

hansgrohe

13596XXX

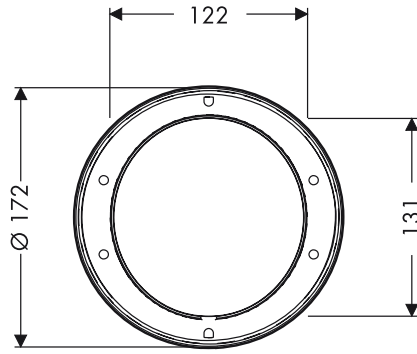
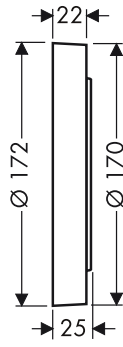

13597XXX

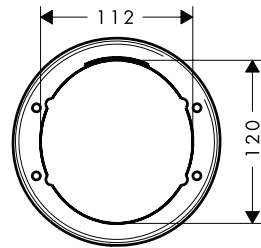
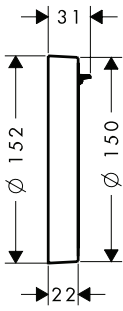

15597000

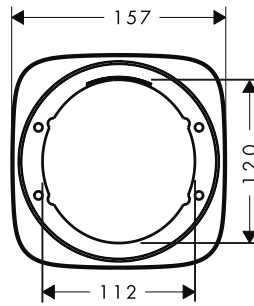
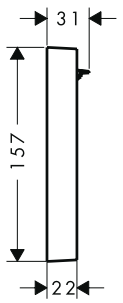

97407XXX

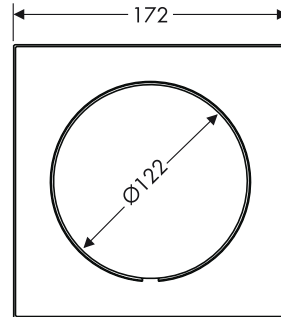
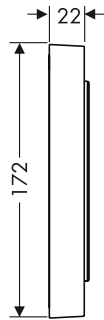

98860000

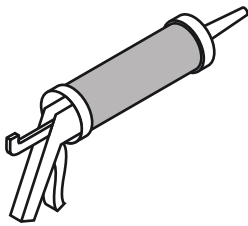
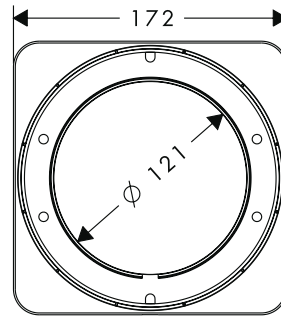
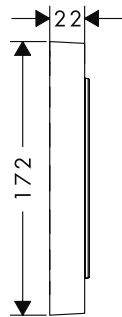

- * Silikon (essigsäurefrei!)
- * Silicone (sans acide acétique!)
- * Silicone (free from acetic acid!)
- * Silicone (esente da acido acetico!)
- * Silicona (¡libre de ácido acético!)
- * Silicone (azijnzuurvrij!)
- * Silikone (eddikesyre-fri)
- * Silicone (sem ácido acético)
- * Silikon (neutralny)
- * Silikon (bez kyseliny octové!)
- * Silikon (bez kyseliny octovej!)
- * 硅胶 (不含醋酸)
- * Силикон (не содержит уксусной кислоты!)
- * Szilikon (ecetsavmentes!)
- * Silikoni (etikahappovapaa!)

- * Silikon (fri från ättiksyra!)
- * Silikonas (be acto rūgšties!)
- * Silikon (ne sadrži kiseline)
- * Silikon (asetik asit içermeyen)
- * Silicon (fără acid acetic!)
- * Σιλικόνη (δίχως οξικό οξύ!)
- * سيليكون (خالي من حمض الخليك!)
- * Silikon (brez ocetne kisline)
- * Silikoon (äädikhappeta!)
- * Silikons (etiķskābi nesaturošs!)
- * Silikon (ne sadrži sirćetnu kiselinu!)
- * Silikon (uten eddikesyre)
- * Силикон (без оцетна киселина!)
- * Silikon (pa acid uthulle!)

